

Security Survey

Take out the form

This form was designed to be positive, any item checked "No" is an area to improve or change

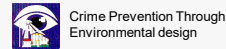

11

Start Across the Street



The address is easily visible and readable from a distance in a contrasting color from background? Illuminated after dark?

12

 PHOENIX POLICE DEPARTMENT

Both of these photos were from a neighborhood with a "rash of window entry" burglaries



The front windows and doors are visible to neighbors and passers-by?

13

 PHOENIX POLICE DEPARTMENT



The landscaping is properly maintained to allow open sightlines and eliminate hiding places?

14

Landscaping Guidelines

- Tree branches 6 –7 feet from the ground
 - Opens up view increasing natural surveillance
- Bushes kept shorter than 36”
 - If near a window kept below windowsill level
 - Prevents concealment during entry

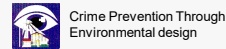

15



There are no areas of easy concealment

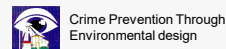

16



• Consider planting thorny plants under windows and around fences

- Cactus
- Roses
- Bougainvillea
- Pyracantha



Barrier plants are used in vulnerable places to prevent or limit access.



Crime Prevention Through Environmental design

17



The Gate is Kept Locked

- **Criminals like a clear escape**
 - Fences slow them down
 - Prevents removal of heavy items
- **We do not recommend placing glass, tar or carpet tack strips on top of fence**
 - Police and fire often have to climb fences



Crime Prevention Through Environmental design

18

No objects to climb fence



19

The house is maintained and appears occupied

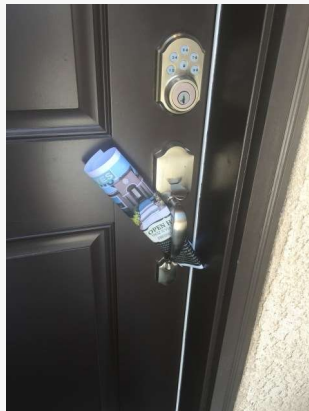

20



Outdoor lighting at night even when not at home



- Porch and garage lights left on all day signal you are away
- Use photocells



All Doors Are Kept Locked

- At night
- Or when away
 - Even for just a few minutes



Spare keys are secured or with trusted friend

- Not
 - Under mat
 - In planter
 - In mailbox
- Lock box



23

No objects are available to force entry into the house



24

Doors are Solid Wood or Metal Clad



25

Front door has a wide-angle Eye Viewer

- AKA peep holes
- Minimum of 180 degree



26

Properly Installed deadbolt lock

- **Deadbolt**
 - Good choice if
 - Installed properly
 - Quality lock is used
 - Bolt is dead (cannot be pushed in)

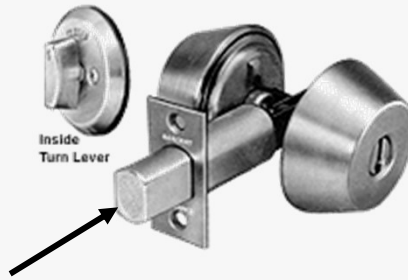

27

Strike Plates Have 2-3 inch Screws

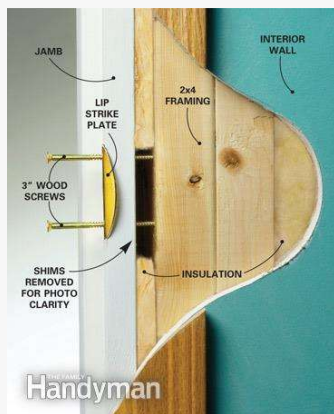

- Screws need to go into the framework of the wall
- The bolt engages far enough to “click”

28

The keys have been changed since you moved in



29

No mail slots or openings within 40 inches of the lock



30



Additional security measures have been added for locks within 40 inches of a window.

- Double cylinder deadbolt locks
- Break resistance glass
- Burglary resistant window film



31



Burglary Resistant Window Film Demonstration



32

Out-swinging Doors

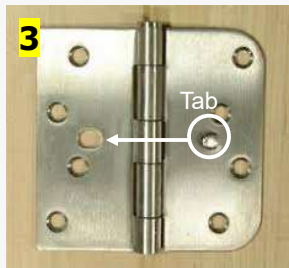

- Proper hinges

Crime Prevention Through Environmental design

33

Double Doors have slide bolts top and bottom

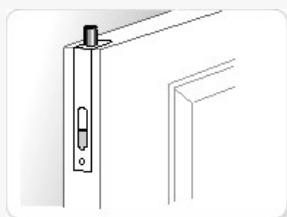

34

Sliding / Arcadia Doors

- Cannot be lifted from track



35

Sliding / Arcadia Doors

- Manufacturer's lock/latch works & secondary lock/latch is in place
- "Charlie bar"
- Pin or slide bolt
- Dowell / stick

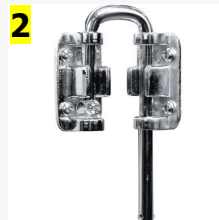

36

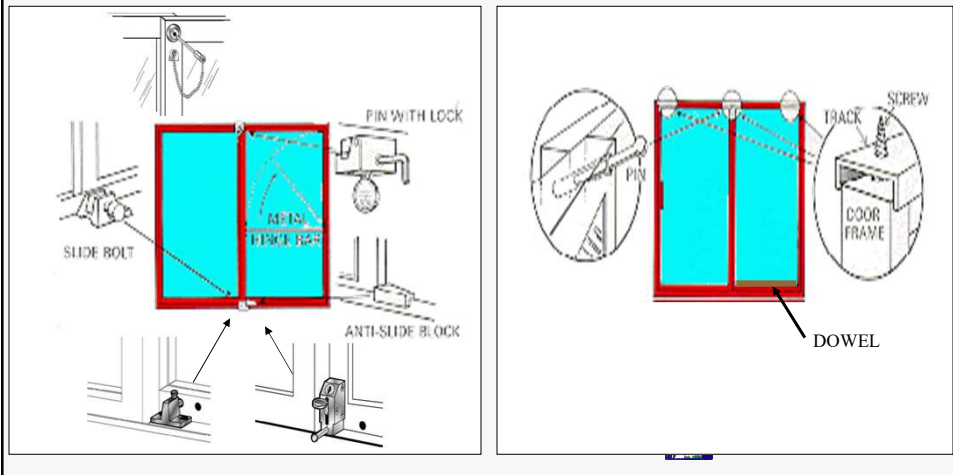

37

Windows



- Windows are left unlocked more often than are doors
- Many ways to secure windows depending on the type of window

38

The manufacture's lock works properly, and window has a secondary lock/latch in place

- Window cannot be lifted from track in the closed position

39

Sliding Windows

- Very common
- Many Secondary locks on the market
- Thumbscrew locks can be placed on the track



40



Casement Windows

- Aka "Crank Open"
- Does lever "catch"



Crime Prevention Through
Environmental design

41



Garages and Carports

- Door between house and garage
 - Secured just like exterior door
 - Not left unlock when away



Crime Prevention Through
Environmental design

42



PHOENIX POLICE DEPARTMENT

Garage Door is Closed When Unattended



Crime Prevention Through
Environmental design

43



PHOENIX POLICE DEPARTMENT

Carport is not used to store valuables



Carport attic entrance is locked



Crime Prevention Through
Environmental design

44

Backyard

- Tools ladders, bicycles, and equipment are locked up
- Shed
- All gates are locked

45

Alley

- Consider adding address to your fence
- Helps PD and Fire Response
- No objects can be used to climb fence



46



Pet Doors

- No large pet doors that allow access to the house

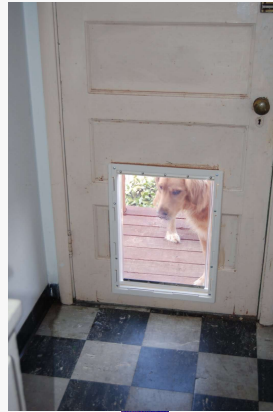

Crime Prevention Through
Environmental design

47



Timer or Photos Cells On Interior Lights

- Interior Lighting
 - Looks like someone is home
 - More comfortable to not enter a dark home
 - Use timers or photo sensors
 - Radios too

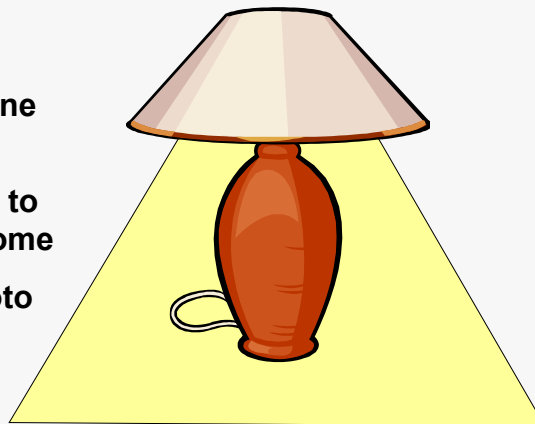

Environmental design

48

Keep An Inventory List

- Serial numbers / photos
 - Regularly updated
- Operation Identification
 - Engraving Drivers License on valuables
- New Technology
 - Micro dots
 - Barcodes

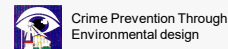

49

Alarm Systems

- Audible / Monitored
- Maintained and tested
- Proper operation
 - Everyone

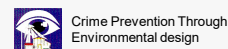

50

Camera Systems

- Doorbell
- Direct to your phone
- Recorded on Cloud



51

Important Documents and High Value Items

- Secured in a good safe
 - Fire Safe vs Burglar Safe
 - Secured in place
- Safe deposit box



52

Don't Advertise Your Valuables

This photo was outside a business that was burglarized "everytime" they got new computers. How did the criminals know?



ANY QUESTIONS?